

日期/Date
 档案员
 Filing Clerk

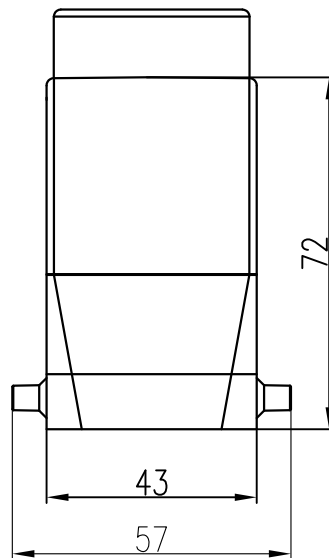
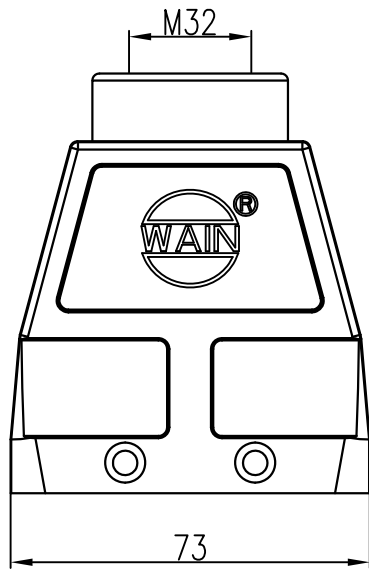

技术参数:

- 材料: 压铸铝
- 表面处理: 粉末喷涂
- 颜色: RAL 7037 (灰色)
- 温度范围: -40℃ - +125℃
- 防护等级: IP65 (联锁状态, IEC 60529)
- 出线方向: 顶出线
- 出线孔数: 1
- 螺纹规格: M32

Technical specification:

- Material: aluminium die-cast
- Surface: powder-coated
- Colour: RAL 7037(grey)
- Temperature range: -40℃ - +125℃
- Degree of protection: IP65
(acc.to IEC 60529 for coupled connector)
- Cable entry: top entry
- No. of cable entries: 1
- Thread size: M32

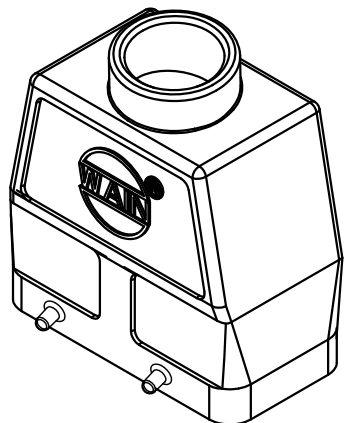

						表面处理 Finish		-		图号 Drawing No.		-		
						材料 Material		-		产品代号 Part Code		HV10B-TEH-4B-M32 WS		
标记 Mark	处数 Number	变更描述/Description			姓名 Signature	日期 Date					产品料号 Part No.		1240104305104	
绘图 Drawn	姓名 Name	日期 Date	标准化 Stand.	姓名 Name	日期 Date	比例 Scale	版本 REV.	重量 Weight	数量 Qty.	产品名称 Part Name		-		
审核 Checked	YL YE	27.03.2019		-	-	2:3	V1.1	-g	-					
工艺 Process	-	-	批准 Approved	HQ ZHANG	27.03.2019			All Dimensions in mm Original Size DIN A 4		厦门唯恩电气有限公司 XIAMEN WAIN ELECTRICAL CO.LTD				