

技术参数:

- 材料: 压铸铝
- 表面处理: 粉末喷涂
- 颜色: RAL 7037 (灰色)
- 温度范围: $-40^{\circ}\text{C} - +125^{\circ}\text{C}$
- 防护等级: IP65 (联锁状态, IEC 60529)
- 出线方向: 顶出线
- 出线孔数: 1
- 螺纹规格: PG29

Technical specification:

- Material: aluminium die-cast
- Surface: powder-coated
- Colour: RAL 7037(grey)
- Temperature range: $-40^{\circ}\text{C} - +125^{\circ}\text{C}$
- Degree of protection: IP65
(acc.to IEC 60529 for coupled connector)
- Cable entry: top entry
- No. of cable entries: 1
- Thread size: PG29

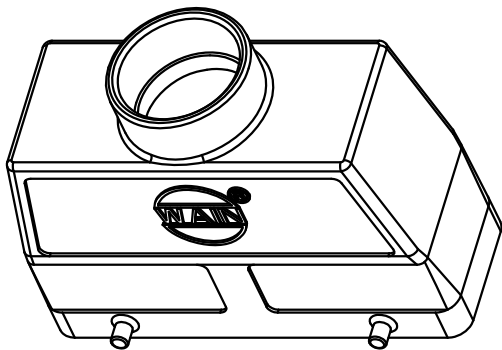

				表面处理 Finish		-		图号 Drawing No.		-	
				材料 Material		-		产品代号 Part Code		HV24B-TEH-4B-PG29	
标记 Mark	处数 Number	变更描述/Description		姓名/Name	日期/Date			产品料号 Part No.		1240244305012	
绘图 Drawn	YL YE	18.12.2018	标准化 Stand.	-	-	比例 Scale	版本 REV.	重量 Weight	数量 Qty.	产品名称 Part Name	
审核 Checked	HZ LAN	18.12.2018				2:3	V1.0	276g	-	-	
工艺 Process	-	-	批准 Approved	HQ ZHANG	18.12.2018			All Dimensions in mm Original Size DIN A 4		厦门唯恩电气有限公司 XIAMEN WAIN ELECTRICAL CO.LTD	