

日期/Date
 档案员
 Filing Clerk

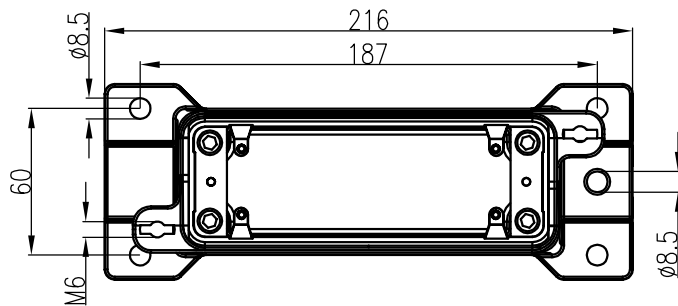
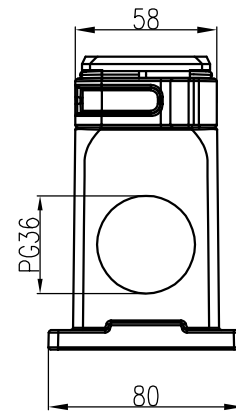
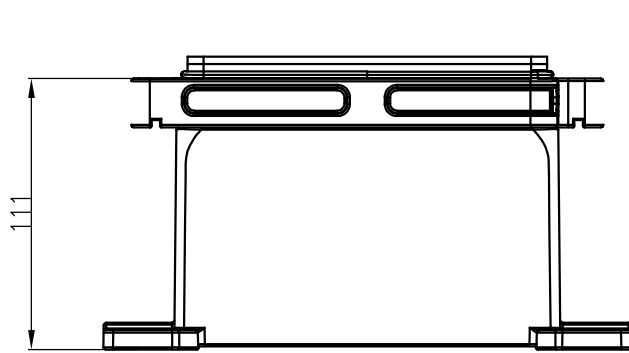

技术参数:

- 材料: 压铸铝
- 表面处理: 粉末喷涂
- 颜色: RAL 9005 (黑色)
- 温度范围: $-40^{\circ}\text{C} - +125^{\circ}\text{C}$
- 防护等级: IP68/IP69K
- 出线方向: 侧出线
- 出线孔数: 1
- 螺纹规格: PG36
- 密封元件: NBR

Technical specification:

- Material: aluminium die-cast
- Surface: powder-coated
- Colour: RAL 9005(black)
- Temperature range: $-40^{\circ}\text{C} - +125^{\circ}\text{C}$
- Degree of protection: IP68/IP69K
- Cable entry: side entry
- No. of cable entries: 1
- Thread size: PG36
- Hoods/Housings sealing: NBR

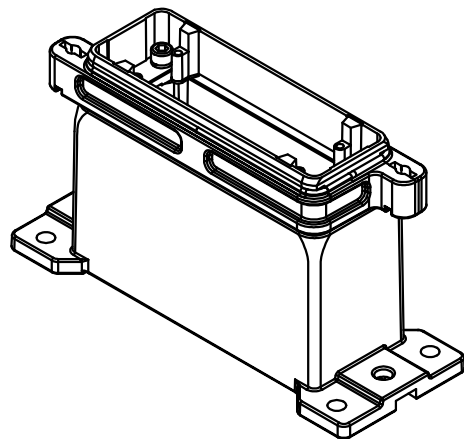

						表面处理 Finish	-				图号 Drawing No.	-	
						材料 Material	-				产品代号 Part Code	HP24B/H-SFH-2T-PG36	
标记 Mark	处数 Number	变更描述/Description			姓名 Signature	日期 Date					产品料号 Part No.	1136242405013	
姓名/Name	日期/Date	姓名/Name	日期/Date	比例 Scale	版本 REV.	重量 Weight	数量 Qty.					产品名称 Part Name	-
绘图 Drawn	SL CHEN	18.10.2010	标准化 Stand.	-	-	1:3	V1.0	1113g	-				
审核 Checked	P RAO	18.10.2010											
工艺 Process	-	-	批准 Approved	YY LIN	18.10.2010			All Dimensions in mm Original Size DIN A 4		厦门唯恩电气有限公司 XIAMEN WAIN ELECTRICAL CO.LTD			